



Applications

General hardware items, such as carabine hooks, quick links and s-hooks, are suitable for many different applications in various market segments like agriculture, industry, transportation, etc.

Range

Van Beest offers a wide range of general hardware products such as:
Carabine hooks in four different types ranging from 4 up to 14 mm.
Two types of quick links ranging from 4 up to 16 mm.
Chain repair links from 3 up to 10 mm.
Spring pins from 2 up to 8 mm.
S-hooks from 3 up to 8 mm.
Linch pins from 4.5 up to 11 mm.

Design

General hardware items are typically designed for multiple purpose usage.

Finish

General hardware items are electro-galvanized.

Certification

All general hardware can be supplied with test certificates upon request.

Instructions for use

Items should be inspected before use to ensure that:

- items are free from nicks, gouges and cracks;
- the item is not used for lifting, general hardware items are not suitable for lifting applications;
- never repair or reshape an item by welding, heating or bending as this may affect its performance.

It is required that the products are regularly inspected and that the inspection should take place in accordance with the safety standards given in the country of use. This is required because the products in use may be affected by wear, misuse, overloading etc. with a consequence of deformation and alteration of the material structure.

Inspection should take place at least every six months and even more frequently when the products are used in severe operating conditions.

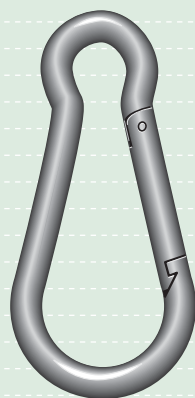

E-7200

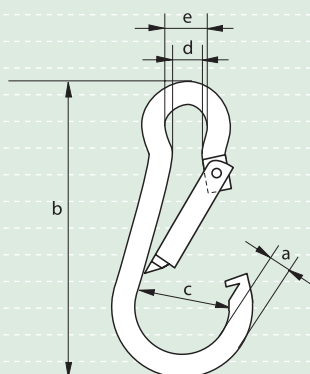

Carabine hooks

standard type

- Material : mild steel
- Finish : electro-galvanized

diameter	length	width	width inside	width inside	minimum breaking load	weight per 100 pcs
a mm	b mm	c mm	d mm	e mm	kg	kg
4	40	14	5	7	-	0.6
5	50	16	7	8	100	0.8
6	60	18	7	9	120	1.6
7	70	22	9	10	180	2.6
8	80	24	11	12	300	4.4
9	90	26	11	12	330	6.4
10	100	30	12	15	460	9.3
11	120	36	14	18	600	12.5
12	140	40	16	20	680	19.5
13	160	44	20	22	800	25
14	180	48	20	22	860	35

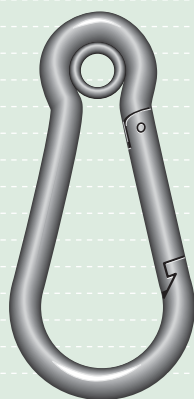

E-7210

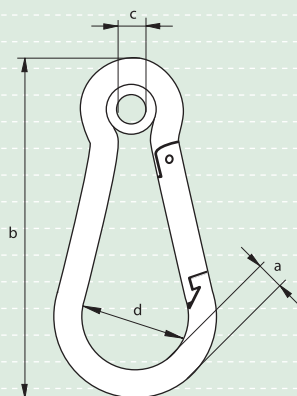

Carabine hooks

with pressed thimble

- Material : mild steel
- Finish : electro-galvanized

diameter	length	diameter inside thimble	width	minimum breaking load	weight per 100 pcs
a mm	b mm	c mm	d mm	kg	kg
4	40	4	14	-	0.8
5	50	5	16	100	1.6
6	60	6	18	120	2.6
7	70	7	22	180	4.4
8	80	10	24	300	6.4
9	90	12	26	330	9.3
10	100	13	30	460	12.5
11	120	13	36	600	19.5
12	140	15	40	680	25
13	160	17	44	800	35
14	180	17	48	860	50

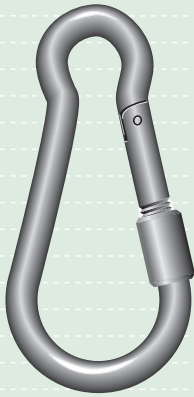

E-7220

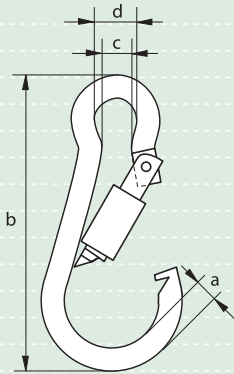

Carabine hooks

with screw nut

- **Material** : mild steel
- **Finish** : electro-galvanized

diameter	length	width inside	width inside	minimum breaking load	weight per 100 pcs
a mm	b mm	c mm	d mm	kg	kg
4	40	4	7	-	1.7
5	50	5	7	100	1.9
6	60	6	8	120	2.9
7	70	7	10	180	4.6
8	80	10	12	300	6.9
9	90	12	12	330	10.3
10	100	13	15	460	13.4
11	120	13	16	600	19
12	140	15	19	680	26.5
13	160	17	28	800	37
14	180	17	28	860	52

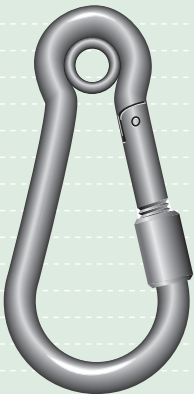

E-7230

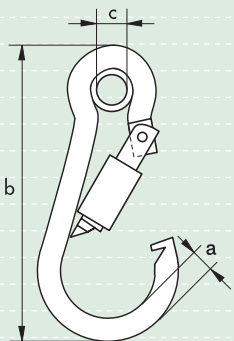

Carabine hooks

with pressed thimble and screw nut

- **Material** : mild steel
- **Finish** : electro-galvanized

diameter	length	diameter inside thimble	minimum breaking load	weight per 100 pcs
a mm	b mm	c mm	kg	kg
4	40	4	-	0.8
5	50	5	100	1.6
6	60	6	120	2.6
7	70	7	180	4.4
8	80	9	300	6.4
9	90	10	330	9.3
10	100	11	460	12.5
11	120	12	600	19.5
12	140	13	680	25
13	160	15	800	35
14	180	17	860	50

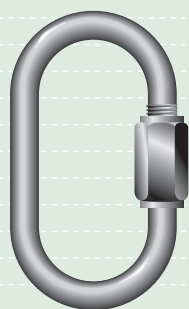

E-7300

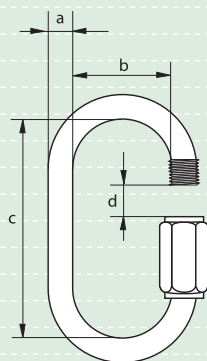

Quick links standard type

- Material : mild steel
- Finish : electro-galvanized

diameter	width inside	length inside	opening	minimum breaking load	weight per 100 pcs
a mm	b mm	c mm	d mm	kg	kg
3.5	10	29	5	240	0.9
4	11	32	5	300	1.3
5	13	39	6	540	2
6	14	46	7	750	3.3
7	16	51	8	1125	5.3
8	17	59	10	1500	7.5
9	17	64	11	2000	10.3
10	20	70	12	2400	13
12	23	83	14	3600	25
14	26	97	17	5000	35
16	29	112	20	6000	50

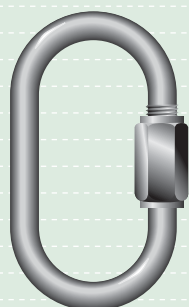

E-7310

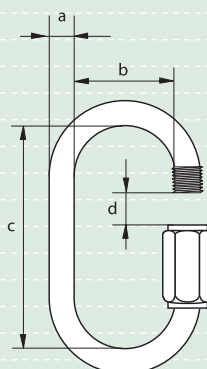

Quick links with enlarged opening

- Material : mild steel
- Finish : electro-galvanized

diameter	width inside	length inside	opening	minimum breaking load	weight per 100 pcs
a mm	b mm	c mm	d mm	kg	kg
4	12	45	11	800	1.4
5	14	52	13	1250	2.5
6	16	58	14	1750	4.2
7	17	65	16	2500	6.7
8	19	73	17	3250	9.4
9	20	79	19	4000	13.1
10	22	88	20	5000	17.5
12	25	102	23	6250	28.2
14	28	114	26	10000	45.6
16	31	129	29	12500	60.7

1
2
3
4
5
6
7
8
9
10
11
12
13
14
15
16

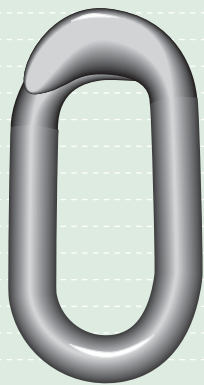

E-7910

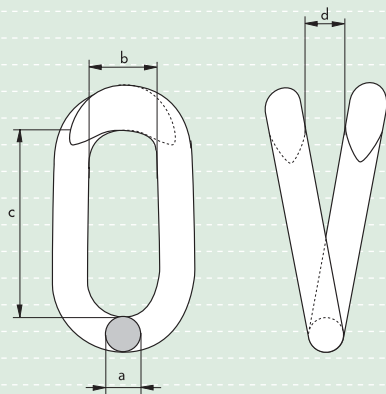

Chain repair links commercial quality

- Material : mild steel
- Finish : electro-galvanized

diameter	width inside	length inside	opening	weight per 100 pcs
a mm	b mm	c mm	d mm	kg
3	6.5	16.5	4	0.4
4	8	20	5.5	0.8
4.5	9	22	6	1.1
5	9.5	23	6	1.2
5.5	10.5	26	6	1.8
6	10.5	29	7	2.1
6.5	11.5	30	8	3.2
7	13.5	32	8.5	3.9
8	15	37	9	5.6
9	16.5	37.5	9	7.6
10	17	37.5	9	9.5

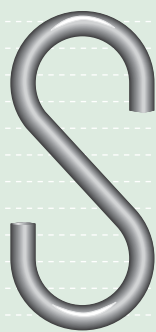

E-7920

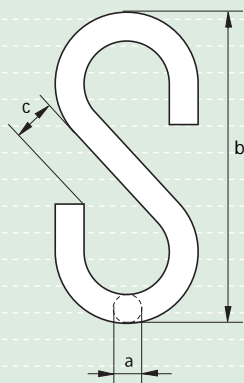

S-hooks standard type

- Material : mild steel
- Finish : electro-galvanized

diameter	length	opening	weight per 100 pcs
a mm	b mm	c mm	kg
3	25	6	0.3
4	35	8	0.8
5	45	9	1.3
6	55	10	2.4
7	65	17	4.3
8	75	20	6.9

Spring pins single type

- Material : mild steel
- Finish : electro-galvanized

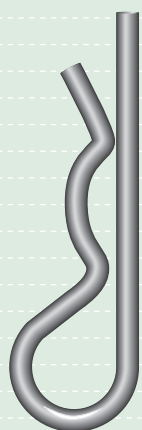

E-7930

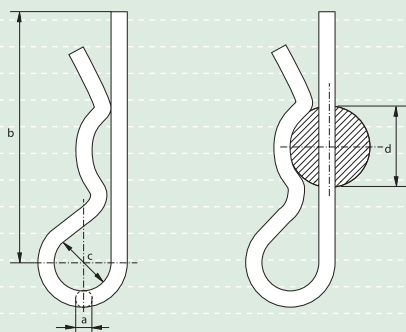

diameter	length	diameter	diameter	weight per 100 pcs
a mm	b mm	c mm	d mm	kg
2	50	10	9 - 14	0.3
3	60	18	10 - 16	0.9
4	60	20	16 - 20	1.6
5	85	24	20 - 28	3.3
6	105	30	28 - 40	6.2
7	105	30	28 - 45	8.3
8	110	28	30 - 45	10.5

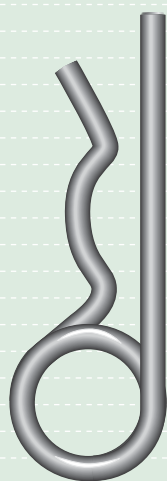

E-7931

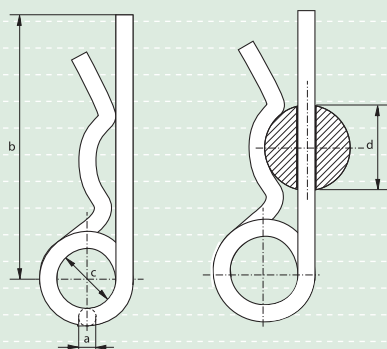

Spring pins double type

- Material : mild steel
- Finish : electro-galvanized

diameter	length	diameter	diameter	weight per 100 pcs
a mm	b mm	c mm	d mm	kg
2	50	10	8 - 14	0.4
3	62	16	14 - 20	1.4
4	78	23	17 - 24	3
5	92	26	18 - 30	5.3
6	120	30	24 - 36	9.6
7	130	30	24 - 40	13.5
8	130	30	24 - 45	17.8

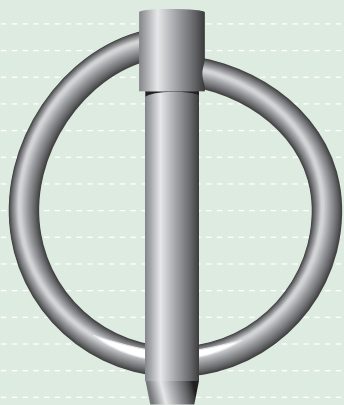

E-7940

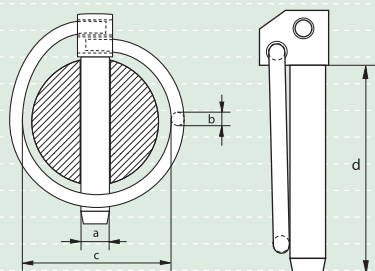

Linch pins with round spring ring

- Material : mild steel
- Finish : electro-galvanized

diameter pin	diameter spring ring	width inside spring ring	length pin	weight per 100 pcs
a mm	b mm	c mm	d mm	kg
4.5	3.4	34	42	2
6	3.4	41	42	2.8
7	3.4	41	42	3
8	3.4	41	42	3.5
9	3.4	41	42	3.8
10	3.4	41	42	4.4
11	3.4	41	42	4.6

1

2

3

4

5

6

7

8

9

10

11

12

13

14

15

16